

6300, 6302

**ELECTRIC
CURTAIN RAIL**
6300, 6302

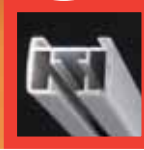

G-RAIL[®]
ALUMINIUM RAIL

> *by Goelst*



G-Rail 6300 series low voltage (24V) electrically operated curtain track systems suitable for light / medium weight curtains.

Easy to install, series 6300 requires no pre-wiring and is enhanced with integrated G-Rail 'CAN-BUS' intelligence.

Developed for contemporary living environments - series 6300 can be used in the hotel, education and leisure industries and by persons with limited mobility.

For heavier curtains or where bends are required G-Rail 6302 should be used.

Standard colours: White RAL 9010, Natural Metallic RAL 9006.

Special colours available on request.

ELECTRIC CURTAIN RAIL

6300, 6302



6300, 6302 > Enhance

Installation

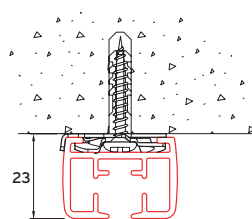

ceiling fixing with clamp 6050

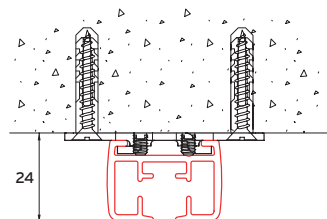

ceiling fixing with 6055-1000

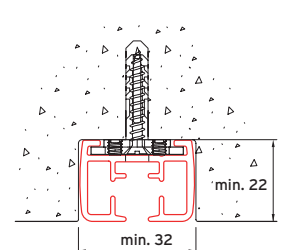

recessed fixing with clamp 6055-2000
When recessing curved rails use profile as manufactured to determine arc

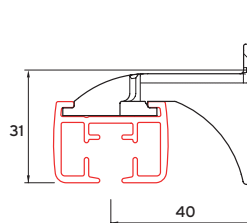

wall fixing with support 6051

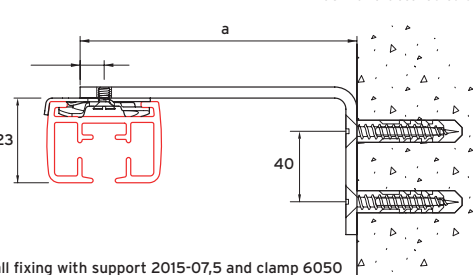

wall fixing with support 2015-07,5 and clamp 6050

	a [mm]
2015-05	50
2015-07,5	75
2015-10	100

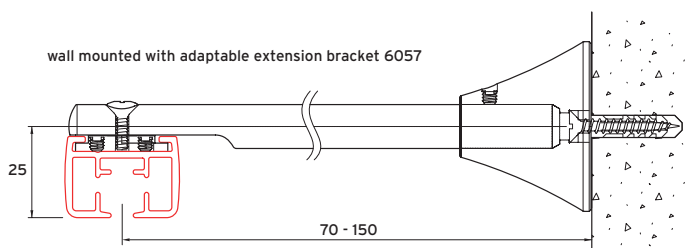

wall mounted with adaptable extension bracket 6057

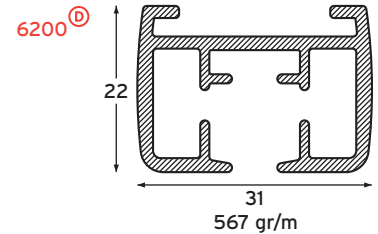

Specification Guide

Special Qualities

- > System suitable for light to medium weight curtains.
- > Delivered pre-wired for simple 24-volt installation.
- > Easy control and setting of the system using infrared remote control supplied.
- > Travel speed max. 13 cm/s, depending on curtain weight.
- > In-built repeat timer function
- > System automatically runs to end positions - determined with endstops 6002.
- > Standard IR control, optional momentary switch (code 6048-1001) RF (radio frequency) also available.
- > Integrated G-Rail 'CAN-BUS' system, allows group / individual control of G-Rail electric curtain tracks.
- > Compatible with most existing BUS systems.
- > Optional 6280-PRS Pilot Release system, allows curtains to be operated by hand in the event of emergency, power failure and/or product unfamiliarity.
- > Enhanced home security
- > 6300 - straight rails only; for heavier curtains or bends use 6302 (or 6200).

anced **technology** with contemporary style

Material:

Aluminium 606035-T6-F22 (higher specification than DIN 1725). Shape and size tolerances are in accordance with DIN 17615. White RAL 9010 or Natural Metallic 9006 powder coated in accordance with the Qualicoat standard. Profile weight: 567gr per linear metre.

Accessories:

Assembled with 10 to 16 gliders per metre. Maximum weight per glider 4010: 1kg. Maximum weight per roller 4030: 1,5kg. Standard maximum total curtain weight for 6300: 20kg and for 6302: 40kg. Upstand headings can be achieved using projection glider 6010. this option has a maximum total curtain weight of 15 kg and can only be used with straight rails < 6 mts.

Installation:

General advice for installation: an extra bracket should be installed at the curtain stacking positions.

Ceiling fixing with bracket 6050 (fixing centres 60-80 cm) and with bracket 6055-1000 (fixing centres 60-80 cm).

Wall fixing with bracket 6051 (projection 4 cm) or with bracket 2015 and clamp 6050.

Wall fixing with adjustable bracket 6057 (projection 7-15 cm). Weight per bracket 6057 up to maximum 10 kg, depending on fixing surface.

Bending (6302 only):

Radius: 20 cm, 30 cm or greater than 1m. Bending machine 1015.

Load table 6300 / 6302

Maximum curtain weight 6300/ 6302 using glider 4010

	> 7 m : split stacked									
	1m	2m	3m	4m	5m	6m	7m	8m	9m	10m
6300 straight	kg 10	20	20	20	20	20	-	-	-	-
6302 straight	kg 10	20	30	40	40	40	40	40	40	40
6302 1 curve	kg 10	20	30	30	30	30	30	30	30	30
6302 2 curves	kg 10	20	20	20	20	20	20	20	20	20
6302 large curve	kg 10	20	20	20	20	20	20	20	20	20

Max. curtain weights - 6300: 20 kg and 6302: 40kg
 Tandem configuration is not available with systems 6300 and 6302;
 (for tandem configuration use system 6200)

This table indicates the maximum total curtain weight when using glider 4010, allowing 10 gliders per metre each with a maximum carrying weight of 1 kg per glider.

Maximum weight per roller 4030: 1.5 kg.

Curve = a 90° curve or two 45° curves

Large curve = gradual curve with a radius of 1 metre or more.

The curtain should not be in contact with the underside of the profile.

For systems larger than given in the table: please enquire.

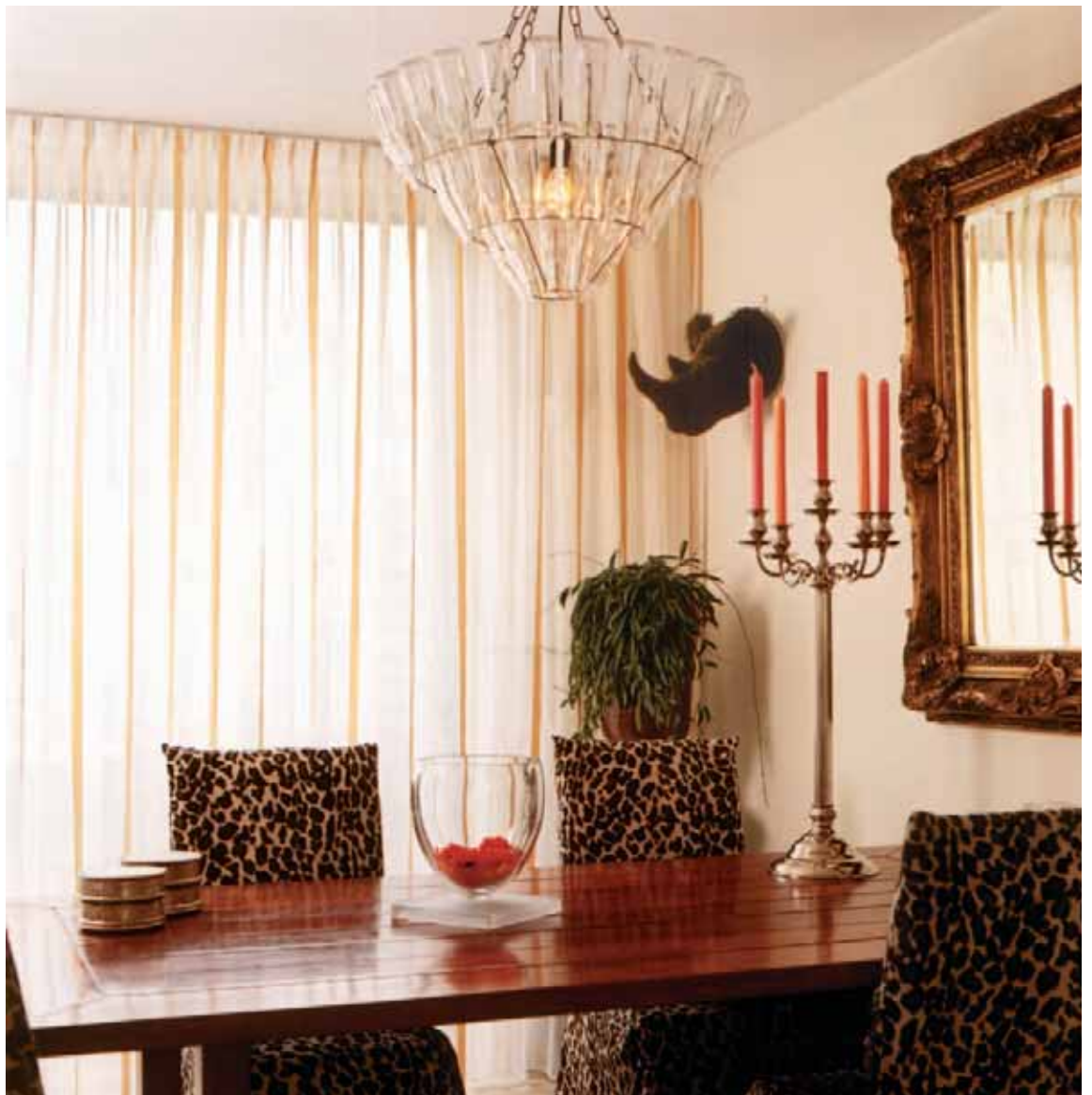

System dimensions

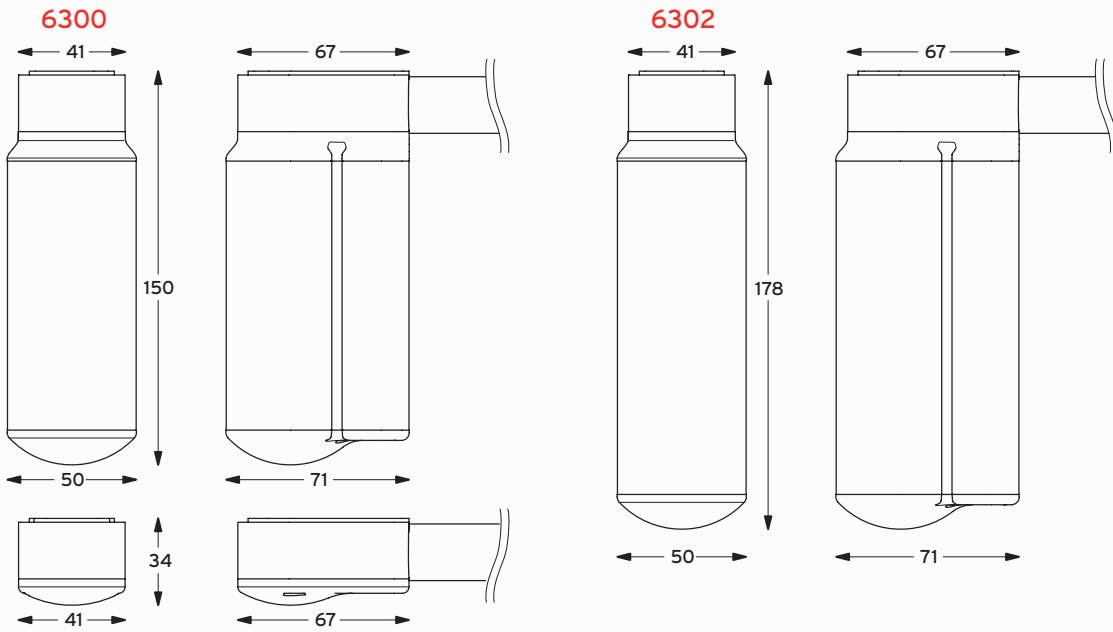

Combination example

Roller panel system 7300 combined with 6300 to achieve electrical operation

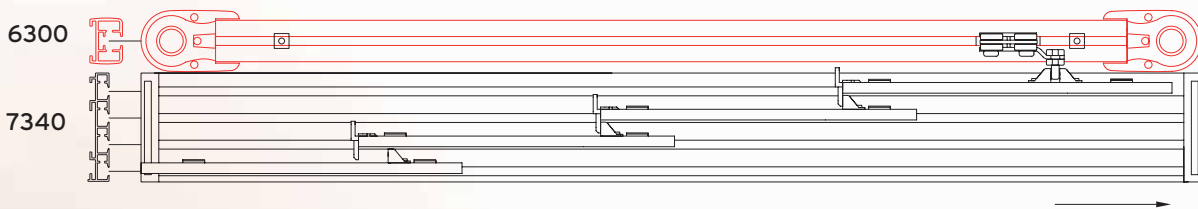

Exploded View

6300-00-EU

contents of basic set shown in red below
(also available in UK and US versions)

ordering components separately:

motor set	+ fixings	+ profile	+ gliders	+ drive belt	+ see component page
6300-00	6050	6200	4010	6320	
6300-10	6055		4030		
6300-20			6010		
6302-00					
6302-10					
6302-20					

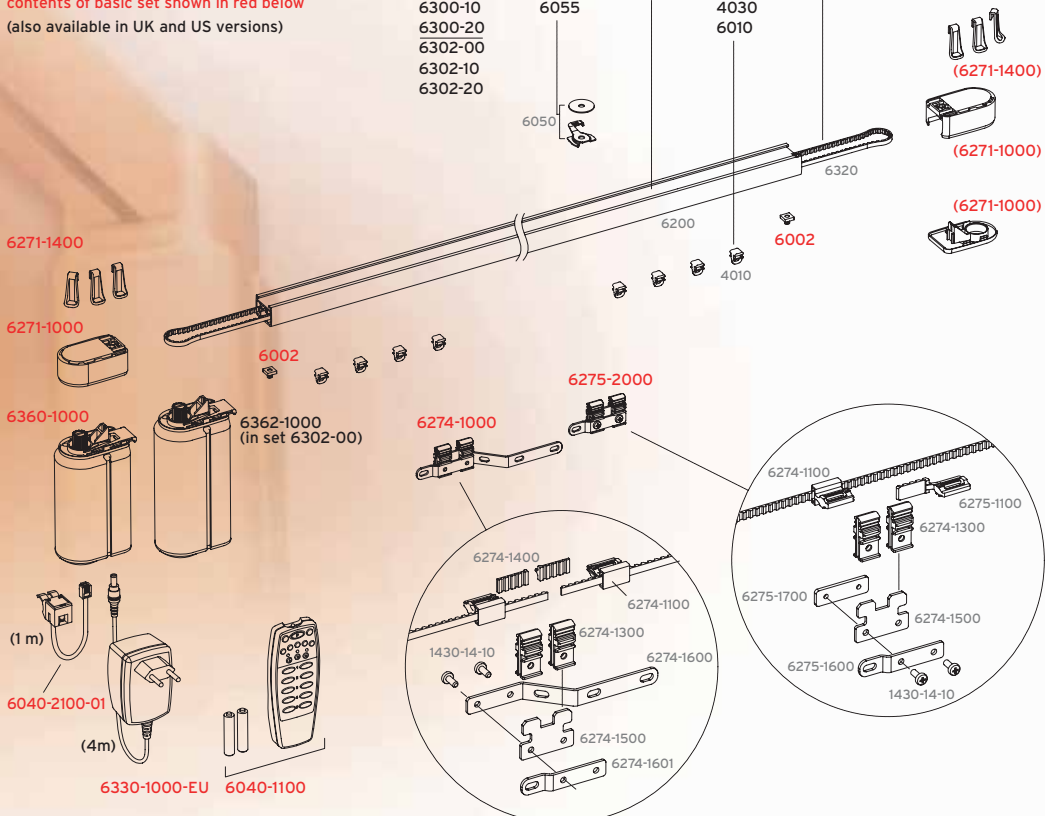



When ordering components for self assembly:*)
 -Select Motor set :
 -Profile 6200
 -Drive belt 6320 (6300) or 6220 (6302)
 -Component parts:
 see Curtain transport, Fixing
 and Accessories sections below

6300-10
 Motor set with single motor, excluding infrared
 controls. Incl. switch 6048-1001-03
6302-10 stronger motor for 6302

6300-20
 Motor set with single motor, excluding controls:
 Select controls from the "Connect and Control"
 brochure. **6302-20** stronger motor for 6302

◀ **6300-00**
 Basic set for systems with single motor,
 including infrared control (see exploded view)
6302-00 stronger motor for 6302

*) When ordering complete assembled systems
 please use our ordering form.

6200
 aluminium profile
 colours: NM - W

6320
 drive belt for 6300 (6 mm)
6220
 drive belt for 6302 (10 mm)

CURTAIN TRANSPORT

4010 ^P
 glider (on strip)
 colours: B - G - W - ZW

4030
 roller
 colours: B - G - W - ZW

6010 ^D
 projection glider, total curtain weight 15 kg;
 straight profile only < 6 m.

2024-55
 sew in hook 55 mm
2024-95
 sew in hook 95 mm

CEILING FIXING

6050
 ceiling fixing clamp
 total curtain weight < 25 kg

6055-1000
 ceiling fixing plate
 colours: N - W

Fixing:
 turn & lock

6055-2000-35
6055-2000-45
 profile insert for recessed fixing,
 incl. special screw - pre-drilling 6200
 profile by Goelst / G-Rail

1430-84 35 mm 45 mm

WALL

2015-10
2015-07,5
2015-05
 wall bracket (16x3mm)
 in combination with 6050
 colours: N - W

6057 ^D
 adaptable wall bracket
 7 cm - 15 cm
 colours: NM - W

6051 ^D
 wall support - 4 cm projection

ACCESSORIES

Components for single track with more than one pair of curtains

6274-2000
 overlap carrier for additional
 pairs of curtains on single track

6274-2000 6275-2000
 additional
 pair of curtain

6275-2000 overlap carrier in combination with 6274-2000
 for additional pairs of curtains on single track

6059
 wall return set (L&R) 15 cm,
 for wall and ceiling mounting - can be
 trimmed (minimum 9 cm)
 colours: W

6280-PRS
 Pilot Release System 6280-PRS
 See PRS brochure for options

CONTROL OPTIONS

The extensive range of control options are featured in our 'Connect and Control'
 Brochure - alternative control options are available on request.

ELECTRIC CURTAIN RAIL
 # 6300, 6302

- B = Brown
 - G = Gold
 - GR = Grey
 - N = Natural
 - NM = Natur metallic
 - W = White
 - ZW = Black
- ◀ = standard item
 - ^D = registered design
 - ^P = patented design

Space for dealer address